

XY-X Series

Product Lineup

CARTESIAN ROBOTS

Offering a full lineup of Cartesian robots that come with exact performances and sizes supports a wide variety of applications.



Fulfilling product lineups

Fulfilling product lineups are provided, such as compact and low price PXYx type, HXYLx allowing long-distance transfer with a maximum payload of 50kg, and NXY with hollow servomotor used for the X-axis applicable to double-arm. Fulfilling arm and performance variations support the customers' various requests.

Additionally, various custom-order products other than models stated in the catalog are also supported. For detail, please feel free to consult YAMAHA.

Fulfilling product lineups support a wide variety of applications.

Various variations

P.242

Models with 3 or more axes can be selected from: ■ Z-axis clamped base and moving table type
 ■ Z-axis clamped table and moving base type

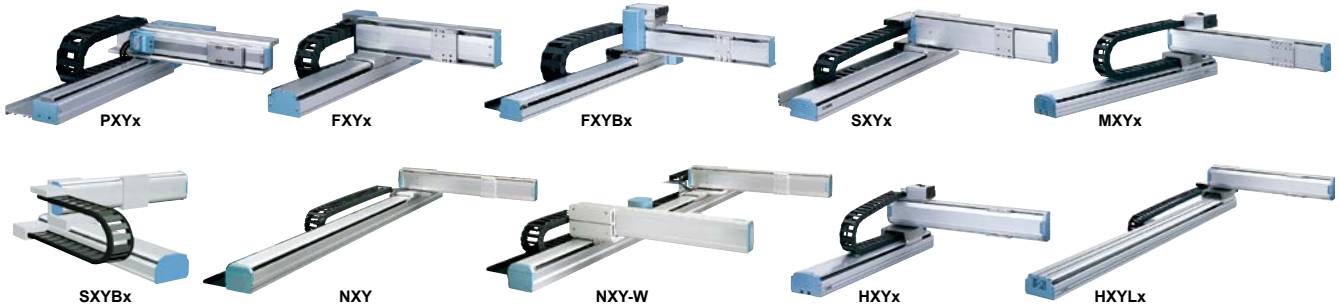

Model	Applicable arm variations					Number of axes	Maximum payload (kg)	Maximum stroke (mm)	
	Arm	Gantry	Moving arm	Pole	XZ			X-axis	Y-axis
PXYx	●	-	-	-	-	2 axes	4.5	150 to 650	50 to 300
FXYx	●	-	-	-	-	2 axes/3 axes	12	150 to 1050	150 to 550
FXYBx	●	-	-	-	-	2 axes	7	150 to 2450	150 to 550
SXYx	●	-	●	●	●	2 axes/3 axes/4 axes	20	150 to 1050	150 to 650
SXYBx	●	-	-	-	●	2 axes/3 axes/4 axes	14	150 to 3050	150 to 550
MXYx	●	●	●	●	●	2 axes/3 axes/4 axes	30	250 to 1250	150 to 650
NXY	●	-	-	-	-	2 axes/3 axes	25	500 to 2000	150 to 650
NXY-W	●	-	-	-	-	4 axes/6 axes	25	250 to 1750	150 to 650
HXYx	●	●	●	●	●	2 axes/3 axes/4 axes	40	250 to 1250	250 to 650
HXYLx	●	●	-	-	-	2 axes	40	1150 to 2050	250 to 650

Note. The maximum payloads and maximum strokes shown above are values when using arm type/cable carrier specifications.

POINT 1

Use of 4-row circular arc groove type 2-point contact achieves high durability.



4-row circular arc groove type 2-point contact guide with less differential slip is adopted. When compared to the 2-row Gothic arch type 4-point contact guide, the robot provides features that it does not stop due to catching or overload and is difficult to malfunction even under poor conditions with low installation surface accuracy or large overhang amount. Guide rail type suitable for Cartesian robots, to which moment is always applied.

2-row gothic arch groove type 4-point contact guide

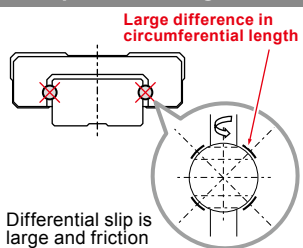

Differential slip is large and friction resistance is large.

- Easy to receive effects of poor installation surface accuracy, friction, and elastic deformation.
- Breakage may occur even within the calculated service life.

4-row circular arc groove type 2-point contact guide

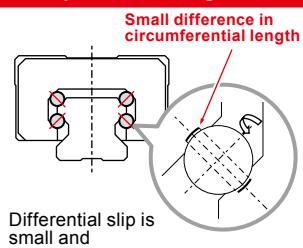

Differential slip is small and self-centering function is high.

- Resistant to alignment changes and moment loads.
- Difficult to break.

POINT 2

Highly reliable resolver is used.



A resolver is used for the position detector. As the resolver uses a simple and rigid structure without using electronic components and optical elements, it features high environment resistance and low failure ratio. Detection problems due to electronic component breakdown, dew condensation on or oil sticking to the disk that may occur in optical encoders do not occur in the resolver due to its structure. Additionally, as the absolute specifications and incremental specifications use the same mechanical specifications and common controller, desired specifications can be selected only by setting parameters. Furthermore, even when the absolute battery is consumed completely, the robot can still operate as the incremental specifications. So, even if a trouble occurs, the line stop is not needed to ensure the safe production line. Furthermore, the backup circuit has been completely renovated and now has a backup period of one year in the non-energizing state.

POINT 3

Easy maintenance

Even when the built-in structure is used, the motor or ball screw can be replaced individually to ensure smooth maintenance work.

POINT 4

Low price

It was succeeded to reduce the number of parts while improving the basic performance. So, further cost reduction was achieved. Additionally, the resolver was used to eliminate the existing image "absolute specifications are expensive". Additionally, both the absolute specifications and incremental specifications use exactly same mechanical parts.

POINT 5

Lightweight and compact

The ball screw drive motor is renovated to a couplingless built-in structure to make dead spaces small and contribute to space saving.

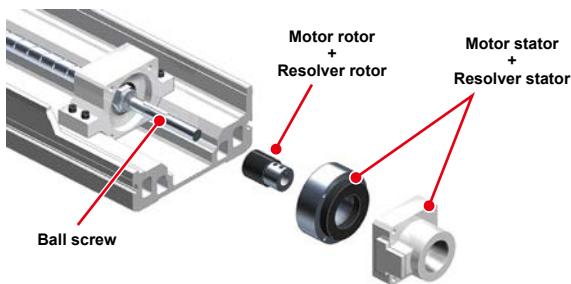

POINT 6

Double Y-axis available as standard

The NXY with nut rotation type structure supports a double Y-axis with two carriers arranged on the same axis. Two Cartesian robots can be made compact to improve the work efficiency at a low cost and ensures the space saving.

- Layout using two conventional Cartesian robots
- Space saving and process integration using NXY-W

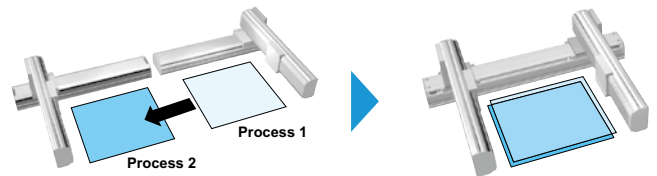

Arm & cable variations

Cable variations

Two kinds of cable specifications, cable carrier and whipover (separate cable), are available. (PXYx uses only the cable carrier.)

● Cable carrier (C)

[User cable is provided as standard equipment.]
When adding cables into a cable carrier, carefully check the space factor (30 % or less), etc.
Note. User cable: 10-core, 0.3 sq



● Whipover (S)

[User cable and air tubing are provided as standard equipment.]
Be aware that sagging or faulty wiring may occur if a load is applied to the whipover. Additionally, sagging may also occur when using a long-stroke.
Note. User cable: 7-core, 0.2 sq
Note. User tubing: φ 4-air tube, 2 pcs.



Arm variations

2 axes combination

● Arm type

Type with Y-axis slider movement



● Moving arm type

Type with entire Y-axis arm movement



● Gantry type

Type with support guide attached to the Y-axis tip of the arm type

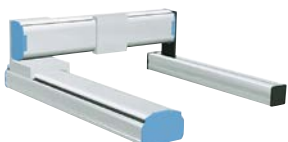

● Pole type

Type with Y-axis slider vertical movement



● XZ type

Type with combination of X-axis for horizontal movement and Z-axis for vertical movement

Clamped table/moving base

Clamped base/moving table

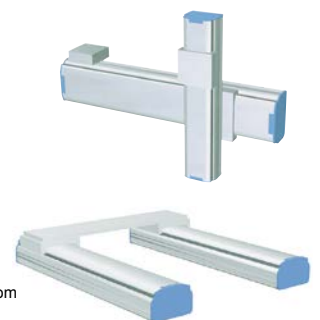

● Dual-robot (2 axes)

Type with synchronous drive between two axes
Note. The dual-robot is supported as a custom order.

3 axes combinations

- Z-axis clamped base and moving table type
ZR-axis model: ZT / ZF / ZFL / ZL

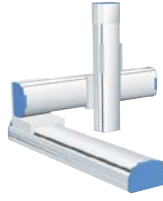

- Z-axis clamped table and moving base type
ZR-axis model: ZFH / ZH

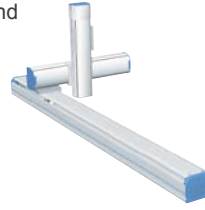

- Shaft up/down type
ZR-axis model: ZS

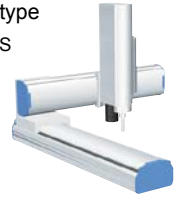

- X-Y Gantry + Z-axis
(Clamped base/moving table)

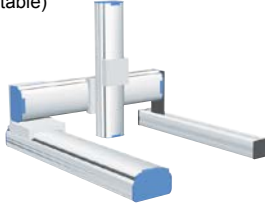

- X-Y Gantry + Z-axis
(Clamped table/moving base)

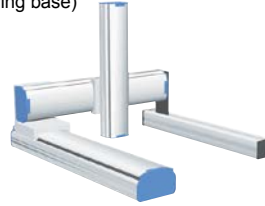

- Dual-robot (3 axes)
Note. The dual-robot is supported as a custom order.

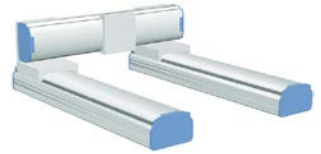

4 axes combinations

- Z-axis clamped base and moving table type + rotation axis
ZR-axis model: ZRF / ZRFL / ZRL

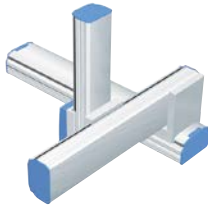

- Z-axis clamped table and moving base type + rotation axis
ZR-axis model: ZRFH / ZRH



- ZR-axis integrated type
ZR-axis model: ZRS

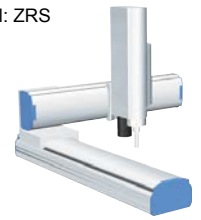

- X-Y Gantry + Z-axis
(Clamped base/moving table) + rotation axis

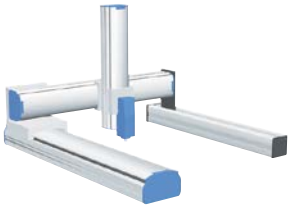

- X-Y Gantry + Z-axis
(Clamped table/moving base) + rotation axis

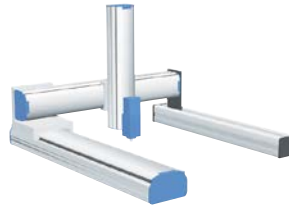

- Dual-robot (4 axes)
Note. The dual-robot is supported as a custom order.



- Double Y-axis specifications
Robot model: NXY-W



6 axes combination

- Double Y-axis specifications/ Z-axis clamped base and moving table type
Robot model: NXY-W-ZFL

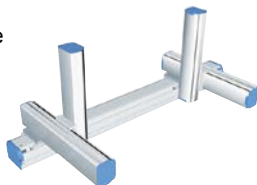

- Double Y-axis specifications/ Z-axis clamped table and moving base type
Robot model: NXY-W-ZFH



Special orders

YAMAHA supports models with strokes and payloads other than the standards as special orders. For detail, please feel free to consult YAMAHA.

Contact Us E-mail: robotn@yamaha-motor.co.jp